

Long-Wave Outdoor Heaters

Lotus Range

LO1200WB, LO1800WB, LO2400WB

Installation Guide

Please read these instructions carefully and in full before installation.
Hardwired installation should only be carried out by a qualified electrician.

Contents

Installation Do's & Don'ts	3
Product Features.....	4
Safety Information.....	5
Installation for Lotus Heaters.....	6
Position Guidelines and Distances.....	7
Operating Instructions.....	8
Wi-Fi Connection Instructions.....	10
Warranty Information.....	11
Contact Us	12

Installation Do's & Don'ts



The Heaters are 240Volt and all hardwired electrical installations must be carried out by a licensed electrician to current local regulations.



The element is operating at around 400°C so the heater will be extremely hot when in use and for a period after it has been switched off. To avoid burns, do not let bare skin touch the unit. Keep combustible materials, such as furniture, pillows, bedding, papers, clothes and curtains at least 150cm from the front of the heater and keep them away from the sides and rear.



Extreme caution is necessary when any heater is used by or near children or invalids and whenever the heater is left operating and unattended.



This product contains two AAA batteries. If a new or used AAA battery is swallowed it can cause severe internal burns and can lead to death in as little as 2 hours. Always completely secure the battery compartment. If the battery compartment does not close securely, stop using the product, remove the batteries, and keep them away from children. If you think batteries might have been swallowed seek immediate medical attention.

Do's

- ✔ Ensure that you read all provided instructions before installing or operating this heater.
- ✔ Disconnect heater, turn controls to off, and turn off power to heater circuit at main disconnect panel before touching, cleaning or moving the heater.
- ✔ Use this heater only as described in this manual. Any other use not recommended by Thermogroup may cause fire, electric shock or injury to persons.
- ✔ Follow correct installation as any alterations to the heater, as well as failure to adhere to the warnings and instructions contained within this manual, may cause property damage, personal injury or death.
- ✔ Ensure that all packaging material is kept out of reach of children.
- ✔ After unpacking, make sure the heater shows no signs of visible damage or tampering. If the appliance appears damaged, contact the place of purchase for assistance.
- ✔ Keep the cable away from sharp edges during handling and installation.
- ✔ Plug the heater into a suitably rated powerpoint that is earthed.

Don'ts

- ✘ Do not use any heater after it malfunctions. Disconnect power at powerpoint or isolation switch and have the heater inspected by a reputable electrician before reusing.
- ✘ Do not insert or allow fingers or other objects to enter the heater, as this may result in an electrical shot or burns.
- ✘ Do not cover the heater as doing so may result in a electrical fire.
- ✘ Never attempt to alter the product in any way.
- ✘ This appliance is not intended for use by persons (including children) with reduced physical, sensory or mental capabilities, or lack of experience and knowledge, unless they have been given supervision or instruction concerning use of the appliance by a person responsible for their safety.
- ✘ Do not touch any part of the heater or plug with wet or moist hands.
- ✘ Do not run the power cord under the carpet or cover with throw rugs, runners etc. and arrange the cord so people will not trip over it.
- ✘ Do not allow the supply cord to sit or hang in front of the heater while in use and keep it away from the body of the heater which will get hot during operation.

If you are unsure or need any help, please call our team on 1300 989 464

Product Features — Lotus Wall/Ceiling Mounted Heater

The Lotus range of long-wave electric outdoor heaters are designed to provide gentle and consistent warmth, making it an ideal choice for creating comfortable outdoor and semi-enclosed spaces. Engineered for high efficiency, these heaters heat the surrounding air, ensuring pleasant heat without the intensity of a visible light glow.

Constructed from durable, weatherproof aluminum, this heater is built to withstand the elements, making it a reliable heating solution. Certified with an IP44 rating, which is safe for enclosed outdoor areas.

NOTE: When the heater is first used you may detect some smell and smog. This is normal. When new, the protective oils used on the element during production will burn off on first use. Allow the appliance to heat up in an open environment and the smell will disappear over a short period.

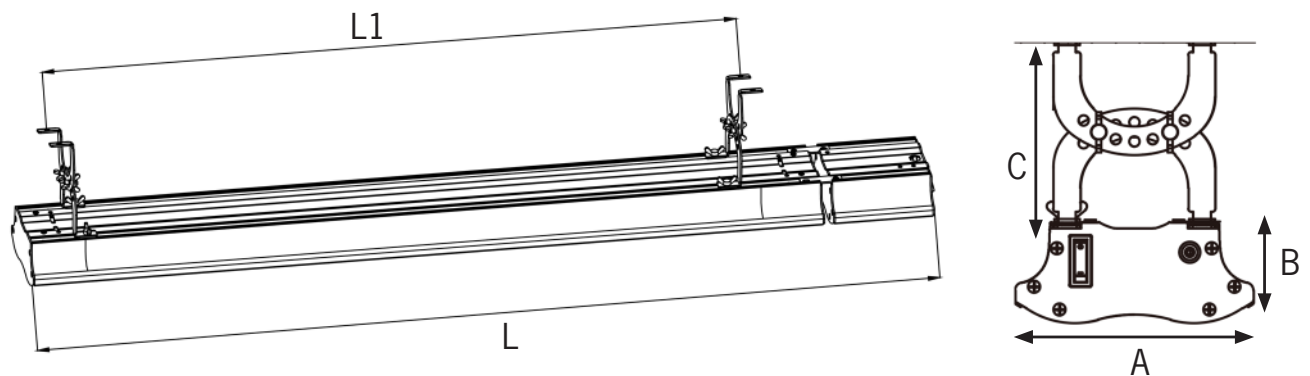

Model	L mm	L1 max mm	A mm	B mm	C mm
LO1200WB	940	707	150	65	120
LO1800WB	1240	1007	150	65	120
LO2400WB	1540	1307	150	65	120

	LO1200WB	LO1800WB	LO2400WB
Width	150mm	150mm	150mm
Length	940mm	1240mm	1540mm
Distance from wall	215mm	215mm	215mm
Voltage	220-240V AC	220-240V AC	220-240V AC
Frequency	50/60Hz	50/60Hz	50/60Hz
Maximum Power	1200Watts	1800Watts	2400Watts
Power Settings	600/1200W	900/1800W	1400/2400W
Wiring Type	Lead and plug	Lead and plug	Lead for hardwiring
Lead Length	1.5m	1.5m	1.5m
Area	Up to 12m ²	Up to 18m ²	Up to 25m ²
IP Rating	IP44	IP44	IP44
Warranty	2 years	2 years	2 years

Safety Information

- Never attempt to carry out an assembly or installation while the electrical power is switched on.
- Remove all protective plastic from the heater before installation.
- Ensure that you refer to the installation precautions under the installation Do's and Don'ts on page 3 before starting to mount the heater.
- A minimum safety distance of 1500mm should always be left in front of the appliance.
- Ensure the unit is mounted in position before turning on the heater.
- Do not plug other high-power appliances in the same socket as the heater to avoid overloading. Ensure the circuit is suitably rated for the wattage of the heater and is protected by a RCD.
- For installation use only the supplied brackets and suitable fixings to mount the brackets to your surface.
- This heater must be installed according to the minimum installation clearances shown in the diagrams on page 7.

Maintenance and Cleaning

- Always disconnect the heater from the electricity supply and allow adequate time (minimum of 30 minutes) for it to cool completely before adjusting the position or attempting to work on it.
- If the heater has collected dust or dirt on the unit or around the heating plate, carefully remove the dust/dirt being careful not to damage the heating plate. Do not operate the heater in this condition.
- Usually the only maintenance required is cleaning of the external surfaces of the heater.
- Do not use powerful abrasive or solvent cleaning fluids when cleaning the heater. Use a damp cloth to wipe the outside of the heater.
- If removed from its mounting position when not in use, store the heater carefully in a safe, dry, childproof location.
- Do not attempt to repair or adjust any electrical or mechanical functions on this heater.
- The heater contains no user serviceable parts. Check for damage to the appliance regularly. If damage to the appliance is suspected, discontinue use immediately and contact the supplier or qualified person to repair it.

Installation for Lotus Heaters

Components

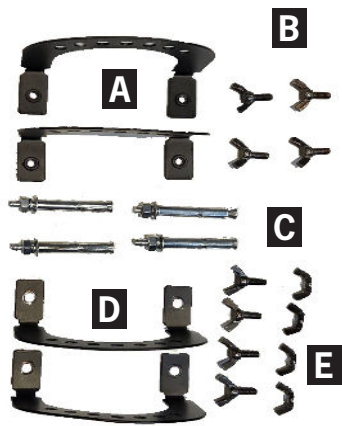

- A: 2 x Mounting bracket for heater
- B: 4 x Wing bolts for attaching to heater
- C: 4 x Mounting Bolts
- D: 2 x Mounting bracket for wall/ceiling
- E: 4 x Wing bolts and wing nuts for fixing wall and heater brackets together

Once you have selected your position (refer to the diagram on page 7) install the heater as per the below.

1. Slide the heater mounting brackets (A) into the groove on the back of the heater and secure tightly with the wing bolts (B). Figure 1.
2. Mark and drill the mounting holes on the wall. Using the mounting bolts (C) provided or fixings suitable to your wall/ceiling type, attach the 2 mounting brackets (D) to the wall/ceiling. Figure 2.
3. Bring the heater up to the mounting bracket. Insert a bolt (E) into the centre holes of the bracket. Lock into position with wing nuts (E). Use the second bolt and wing nut to secure the heater at the desired angle. Figure 3.

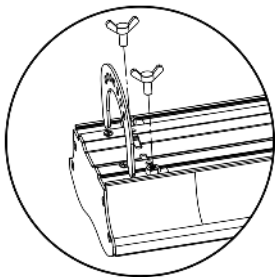

Fig. 1

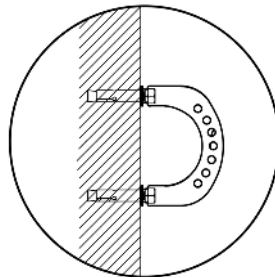

Fig. 2

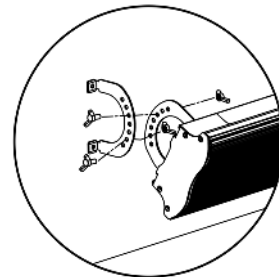

Fig. 3

The Lotus heater can be suspended using chain if required, attaching to the mounting bracket as shown in figure 4.

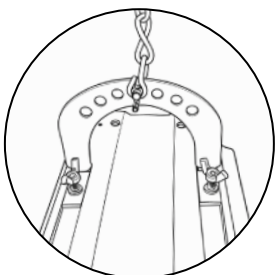

Fig. 4

Position Guidelines and Distances

- A minimum safety distance of 1500mm should always be left in front of the appliance.
- This heater must be mounted at a minimum of 2200mm above the floor.
- The heater should always have a minimum clearance of 200mm from a ceiling and adjacent walls.

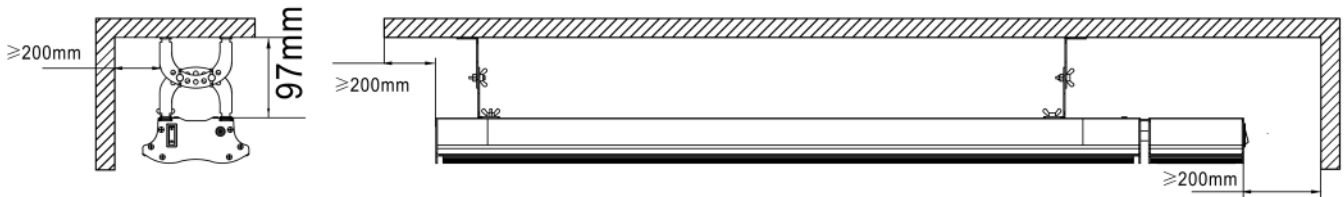

Fig. 5

Ceiling installation: The device back plate must be installed at least 97mm from the wall, the device left and right side must be installed at least 200mm from the wall as shown in figure 5.

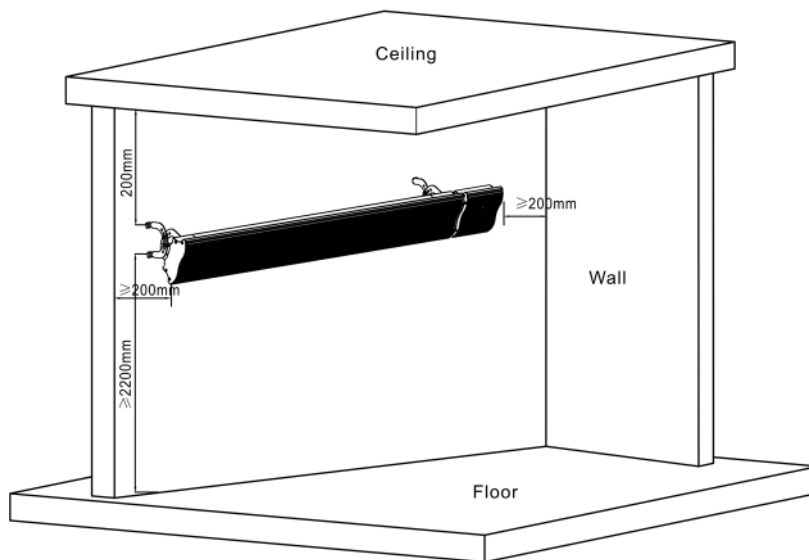

Fig. 6

If the appliance is to be wall mounted the device back plate must be at least 97mm from the wall, the left and right side must be installed at least 200mm from the wall, as shown in figure 6.

Operating Instructions

The heaters come with a remote which allows for selecting the operating power, setting the desired temperature and selecting a countdown timer. You can also control the heater via the mobile application.

Ensure the heater is mounted in position before turning on the heater. Turn the heater on via the isolating switch on the right hand side of the unit.

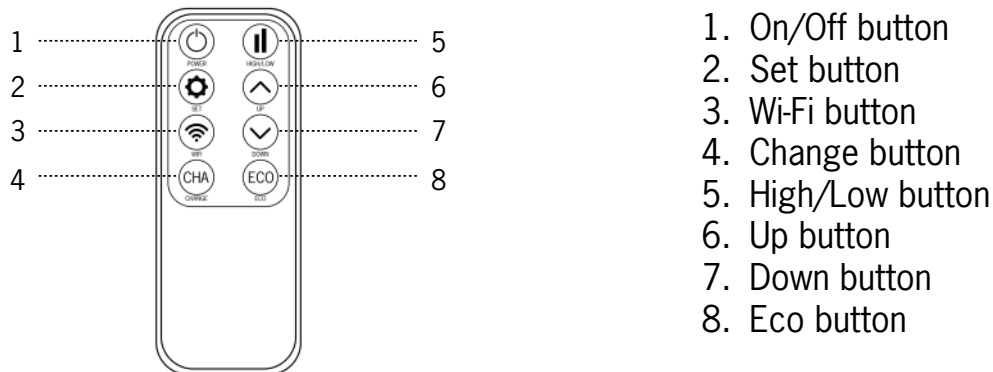

Switch On

Press to turn the heater on and the screen will display the room temperature. If the current room temperature is lower than the pre-set temperature the heating function will begin to operate, and the indicator light will blink.

Temperature Setting

To set the temperature press then press or to increase or decrease by 1°C. The maximum temperature is 45°C.

Once the desired temperature is set the heater will automatically update and return to its normal operational status where the screen displays the room temperature.

Timing Switch Setting

Press twice when on the home screen and the “0” will flash, use or to set the run time. The minimum time is 1 hour and the maximum is 24 hours.

Each time you press or the time will increase or decrease by 1 hour.

When the time is set, the system will automatically save and return to its normal operating status, however, it will now display the time symbol on the screen.

High/Low Setting



When the heater is in operation press to switch between the high (100%) and low (50%) heating setting.

Switch Off



Press to turn the device off.

Operating Instructions

Eco Mode / Display Screen On/Off

Press  to switch off the display. A red light will remain lit if the unit is still heating. Press the  button again to return to the normal display.



Lock Function

Press  followed by  and the lock indicator light will illuminate.



All keys are unoperational when the lock function is activated. Repeat the same steps to unlock the keys.

Open Window Detection

Note: The default factory setting is that the open window detection function is turned off. To enable this function follow the below steps:

1. Press the  button then within 5 seconds press  to activate the open window function and display "ON". After flashing "ON" for 5 seconds, the display screen returns to its original display.

When the temperature drops by 3°C or more within two minutes, the intelligent window detection function will activate and the heater will stop working. The LED display screen will flash and the heater will make a clicking sound. The heater will only resume operation when manually turned on again.

2. When you do not need this function, press  then within 5 seconds press  to deactivate the open window function and display "OF". After flashing "OF" for 5 seconds, the display screen returns to its original display.

Temperature Change

Press the  then press  then press  within 5 second to change the temperature between Fahrenheit and Celsius.

Wi-Fi Connection Instructions

1. Download the “Smart Life” app on your device by searching in the app store or scanning the QR code.
2. Connect to your home Wi-Fi network. NOTE: You will need to connect this heater to a 2.4Ghz network.
3. When the heater is on, press and hold the Wi-Fi button on the remote for 3 seconds and the Wi-Fi indicator icon on the display screen will begin to flash.



4. Open the Smart Life App and select Add Device. If you are near the device, this should automatically appear at the top of the screen. If this does not appear, go to Small Home Appliances and select Heater.

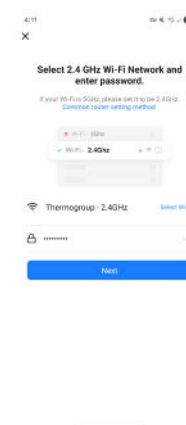
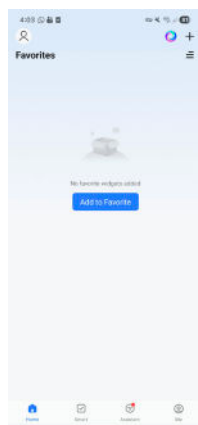

5. Enter the password of your Wi-Fi Network, select Next and the device should be automatically connected.

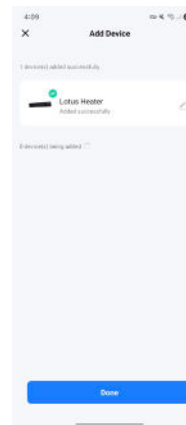
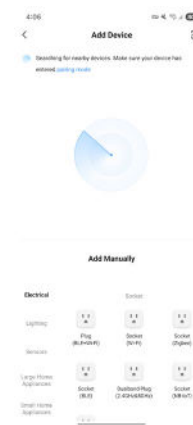
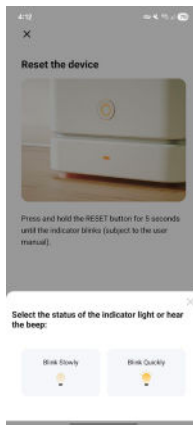
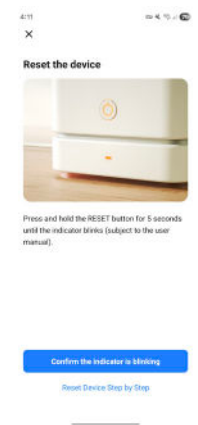

6. Press Done to enter the control interface where you will now be able to control the heater.

7. Use the Control Interface to turn on the heater, set the countdown timer, select the power level, and adjust the advanced settings.

To use the heater on multiple devices, please select the device menu located at the 3 dots at the top right of the screen and go Share Device. You can also rename the device, view the device information, and setup automations in this area.

Warranty

Thermogroup covers all its products with a satisfaction guarantee. In addition, Thermogroup will supply a replacement product where a fault is shown to be caused by manufacture, materials or workmanship providing the goods have been installed correctly and according to installation instructions. This guarantee does not include removal, freight or installation costs. Our goods come with guarantees that cannot be excluded under Australian Consumer Law. You are entitled to a replacement or refund for a major failure and compensation for any other reasonably foreseeable loss or damage. You are also entitled to have the goods repaired or replaced if the goods fail to be of acceptable quality and the failure does not amount to a major failure.

The Lotus Outdoor Heaters have a 2 Year warranty. To use the warranty, repair or service the customer must provide purchase invoice, receipt, and any other relevant details.

If the product develops a fault within the warranty period due to normal wear and tear, Thermogroup at its discretion will recognise whether it's a faulty product or not. If it is impossible or not economical for the manufacturer to repair the product, the manufacturer will replace the faulty product with a new unit of the same model or if there is no stock available of the same model as the product, the manufacturer will replace the product with a new unit of a similar size. No responsibility can be taken for altered dimensions and lining up of existing holes.

The repair service offered within the warranty period only covers the faults and problem as developed from the manufacturer's errors. Any damage caused by improper use or carelessness or incorrect wiring is not covered.

Thermogroup is not responsible for any monetary loss or injuries caused by improper use of this product.



Contact Us

Phone: 1300 368 631 | Technical Helpline: 1300 989 464
sales@thermogroup.com.au | www.thermogroup.com.au