

Thermorail Towel Rails 12V

Electric Heated Towel Rails for use in bathrooms

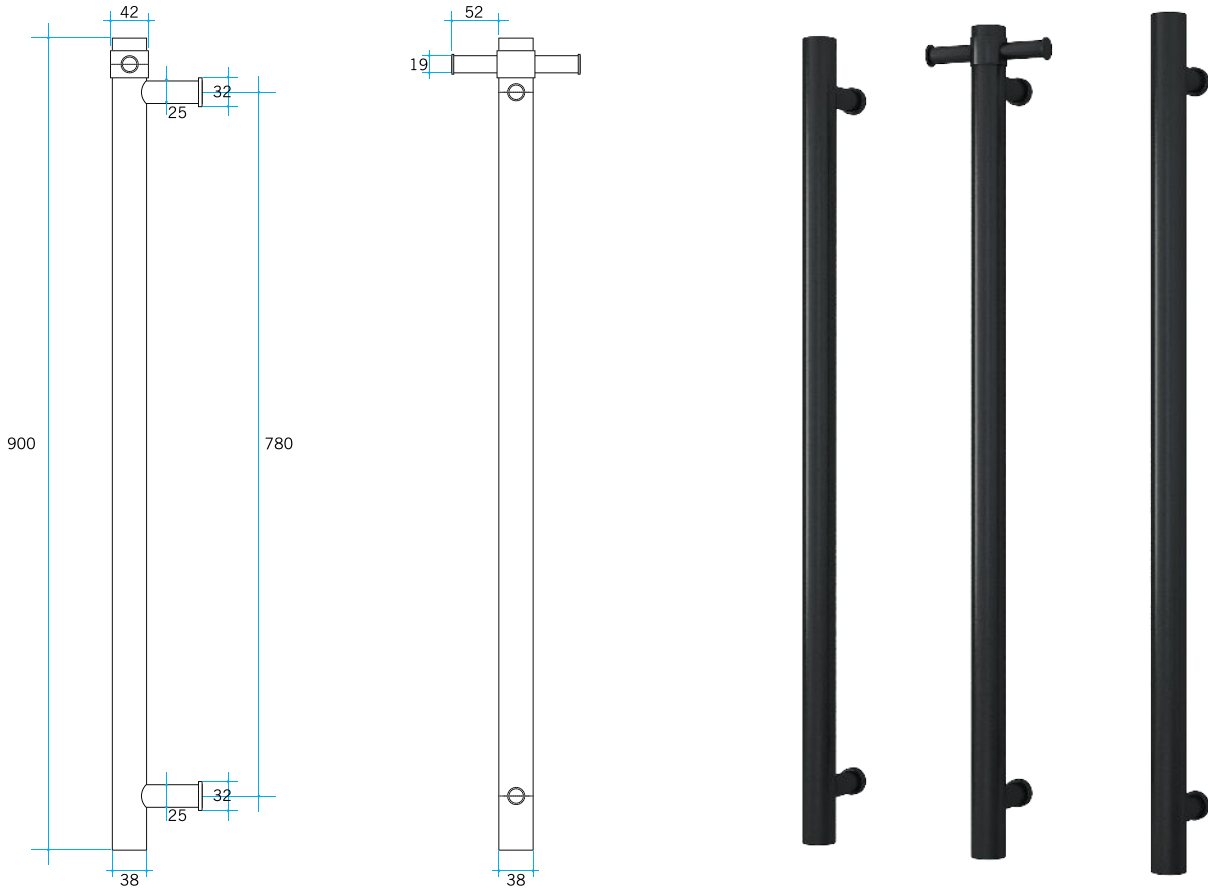

| Stock Code | Finish | Size (mm) | Output (W) | No. of Bars |
|------------|------------|--------------------|------------|-------------|
| VS900HB | Matt Black | W142 x H900 x D100 | 30 Watts | 1 |

Rails are sold individually. Hooks are removable.

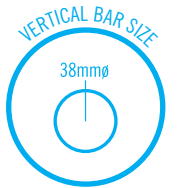
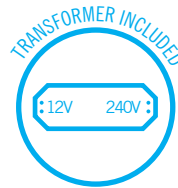
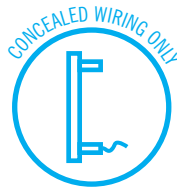

Please note: Specifications are for information purposes only. Whilst every effort has been made to ensure the product specifications are accurate, due to continuing product development and improvement the specifications are subject to change. Specifications can be used to rough in and fit timber supports in the wall however we recommend no holes are drilled without having the product on site or verifying the details with the manufacturer. Thermogroup cannot be held liable or responsible for errors due to updated specifications