

**Thermorail Towel Rails 12V**  
Electric Heated Towel Rails for use in bathrooms

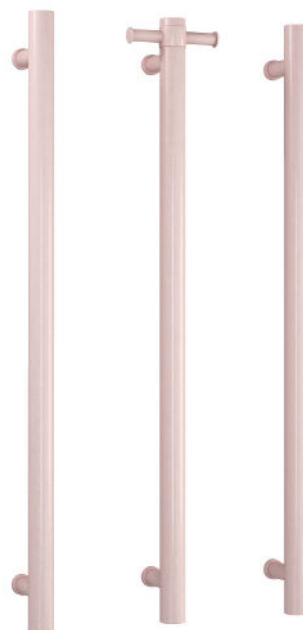
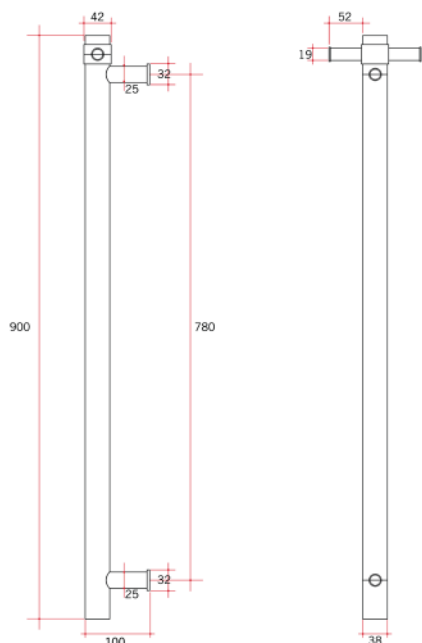

Note: All dimensions are in millimeters (mm)

Stock Code	Finish	Size (mm)	Output (W)	No. of Bars
VS900HDP	Dusty Pink	W142 x H900 x D100	26	1

Rails are sold individually. Hooks are removable.



**Seven year warranty**



**Safe for use in bathrooms**



**Quality stainless steel**

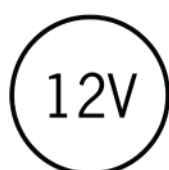

**Safe for use in wet areas**

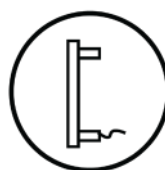

**Concealed wiring only**

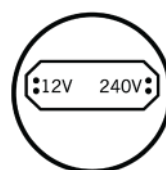

**Transformer included**

(12 month warranty)

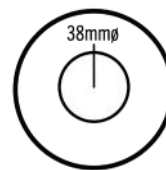

**Vertical bar size**

**PLEASE NOTE:** Specifications are for information purposes only. Whilst every effort has been made to ensure the product specifications are accurate, due to continuing product development and improvement the specifications are subject to change. Specifications can be used to rough in and fit timber supports in the wall however we recommend no holes are drilled without having the product on site or verifying the details with the manufacturer. Thermogroup cannot be held liable or responsible for errors due to updated specifications.