

Thermorail Towel Rails 12V
Electric Heated Towel Rails for use in bathrooms

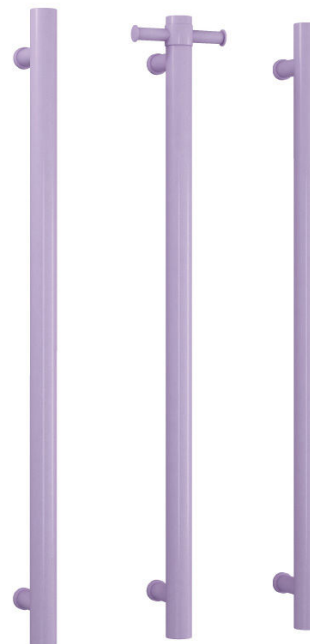

Note: All dimensions are in millimeters (mm)

| Stock Code | Finish | Size (mm) | Output (W) | No. of Bars |
|------------|-------------|--------------------|------------|-------------|
| VS900HLS | Lilac Satin | W142 x H900 x D100 | 26 | 1 |

Rails are sold individually. Hooks are removable.



Seven year warranty



Safe for use in bathrooms



Quality stainless steel



Safe for use in wet areas

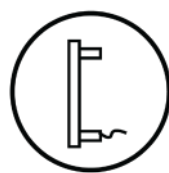

Concealed wiring only

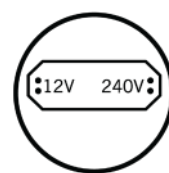

Transformer included
(12 month warranty)

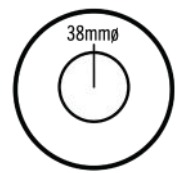

Vertical bar size

PLEASE NOTE: Specifications are for information purposes only. Whilst every effort has been made to ensure the product specifications are accurate, due to continuing product development and improvement the specifications are subject to change. Specifications can be used to rough in and fit timber supports in the wall however we recommend no holes are drilled without having the product on site or verifying the details with the manufacturer. Thermogroup cannot be held liable or responsible for errors due to updated specifications.